



# Mixels™

## TUNGSTER



41544



7 [LEGO.com](http://LEGO.com)

6126534

1



2

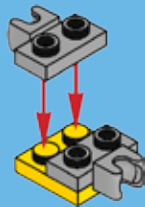

3



4

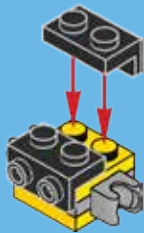

5

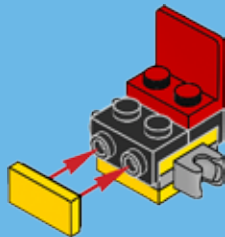

6

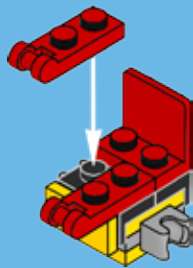

7

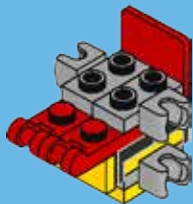

8

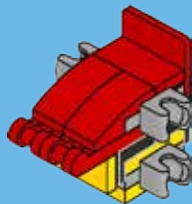

9

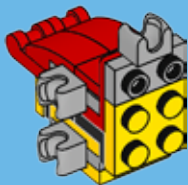

10

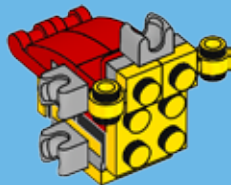

11

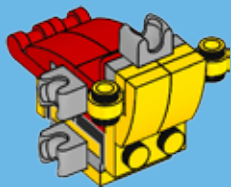

12





13

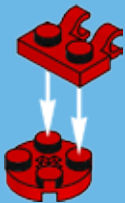

14



15





16

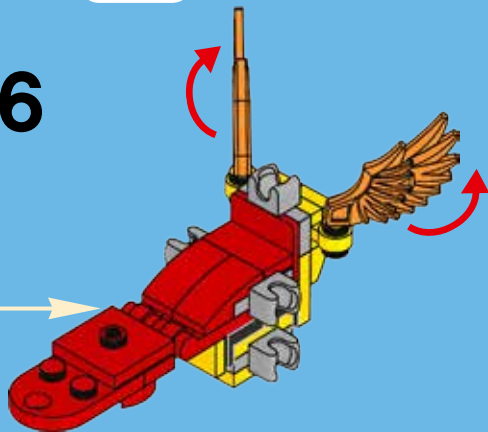



1



2



3



17

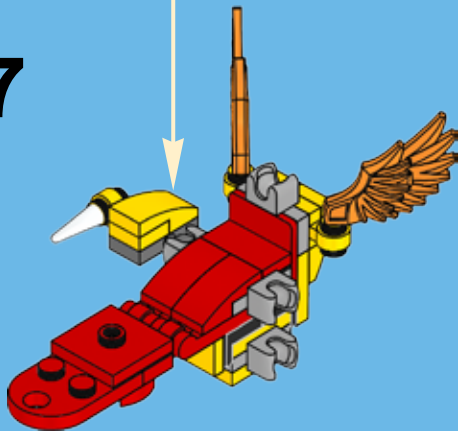

1



2



3



18

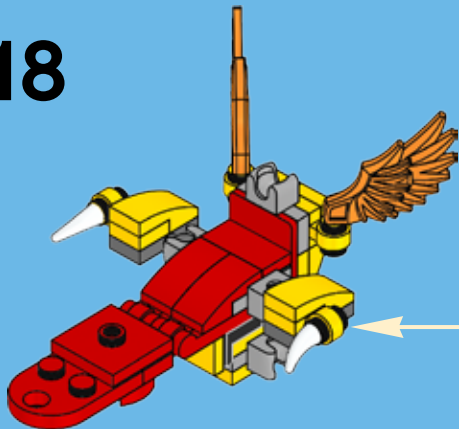



19



20



21

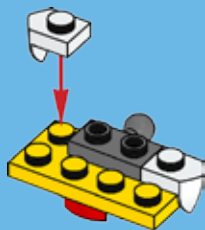

22



23



24



25

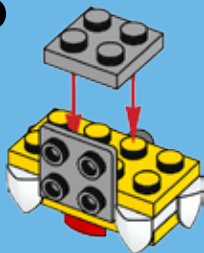

26

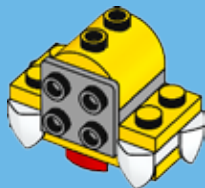

1



2



3



4



27



28

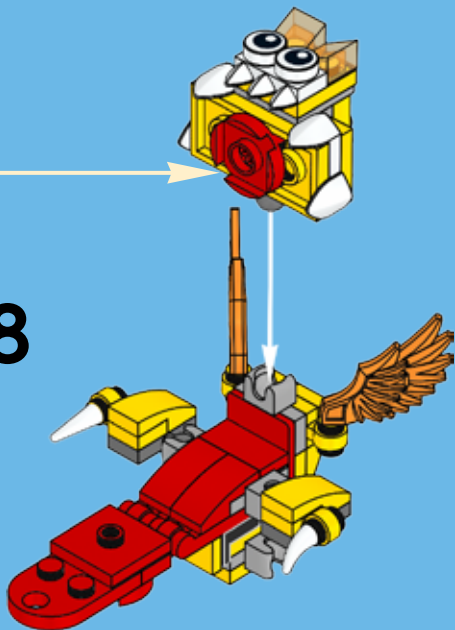

29

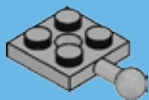

30

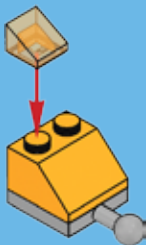

31

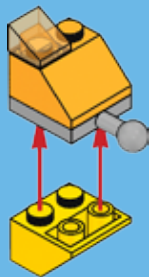



32



33

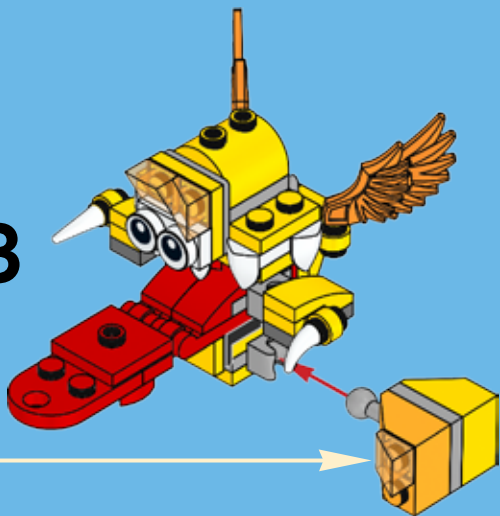

34

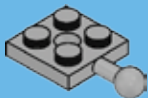

35

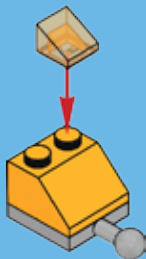

36

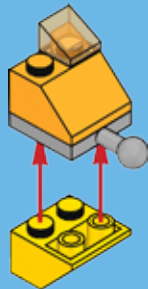

37



38

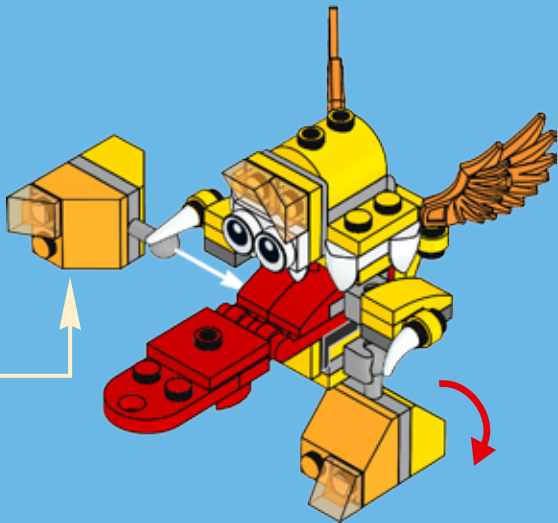



2x  
6057921



4x  
4244369



2x  
6029156



1x  
4211397



2x  
6029946



1x  
4188189



4x  
4632569



3x  
6039479



2x  
4568387



5x  
6043656



1x  
306921



2x  
403221



4x  
302224



2x  
6020181



2x  
6016172



4x  
6046905



1x  
4654580



1x  
4581308



1x  
6001806



2x  
302024



**Customer Service**

**Kundenservice**

**Service Consommateurs**

**Servicio Al Consumidor**

**LEGO.com/service or dial**



**00800 5346 5555 :**



**1-800-422-5346 :**



2x  
6063611



1x  
4556153



4x  
6029947



2x  
366024



2x  
4515365



1x  
306924



1x  
4187061



**SPUGG  
41542**



**LIXERS  
MAX!**



**TURG  
41543**



**TUNGSTER  
41544**



[LEGO.com/mixels](http://LEGO.com/mixels)





# Mixels™

SERIES  
**5**



**41536  
GOX**



**41537  
JINKY**



**41538  
KAMZO**



**41539  
KROG**



**41540  
CHILBO**



**41541  
SNOOF**



**41542  
SPUGG**



**41543  
TURG**



**41544  
TUNGSTER**



[LEGO.com/mixels](http://LEGO.com/mixels)





**YOU CAN  
BUY THE  
GAME!**

**V A 1 K Y R 1 E**

**IN GAME CODE!**

**MIXELS  
RUSH**



Apple, the Apple logo, iPad, iPhone and iPod touch are trademarks of Apple Inc. Google Play is a trademark of Google Inc.